

GRUNAU BABY (1/4 SCALE)
LASER-CUTTING KIT
BUILDING INSTRUCTION



Produced by ValuePlanes

CATALOG

[WWW.4-MAX.CO.UK](http://www.4-MAX.CO.UK)

| | |
|--|------------|
| INTRODUCTION ----- | P1 |
| PRODUCT LIST & KIT FEATURES ----- | P1 |
| GENERAL INFORMATION ----- | P2 |
| BUILDING INSTRUCTION ----- | P3 |
| 1) FUSELAGE FRAME ASSEMBLY ----- | P3 |
| 2) WING CONSTRUCTION ----- | P10 |
| 3) TAIL ----- | P17 |



SPECIFICATIONS:

| | |
|----------------|----------------------------|
| Wingspan: | 3400mm |
| Length: | 1520mm |
| Flying Weight: | 2200g |
| Motor: | 2814 1000kv |
| ESC: | 40A |
| Servos: | 17g × 4 |
| Batteries: | 3-4S |
| Props: | 12--13inches folding props |

INTRODUCTION

THE SCHNEIDER GRUNAU BABY WAS A SINGLE-SEAT SAILPLANE FIRST BUILT IN GERMANY IN 1931, WITH SOME 6,000 EXAMPLES CONSTRUCTED IN SOME 20 COUNTRIES. IT WAS RELATIVELY EASY TO BUILD FROM PLANS, IT FLEW WELL, AND THE AIRCRAFT WAS STRONG ENOUGH TO HANDLE MILD AEROBATICS AND THE OCCASIONAL HARD LANDING. IT WAS DESIGNED BY EDMUND SCHNEIDER WITH THE ASSISTANCE OF WOLF HIRTH AND HUGO KROMER AS A SMALLER VERSION OF SCHNEIDER'S ESG 31 OF THE PREVIOUS YEAR, INCORPORATING AN ELLIPTICAL WING DESIGN BASED ON WORK DONE BY AKAFLEG DARMSTADT. IT WAS NAMED AFTER GRUNAU, THE TOWN WHERE SCHNEIDER'S FACTORY WAS LOCATED, NOW JEZÓW SUDECKI IN POLAND.



PRODUCT LIST

| | |
|---------------------------------------|-----------------------------------|
| Balsa sheets pack*1 | 1:1 installation drawing*1 |
| Batten sets | Operation instruction*1 |
| Accessories bag*1 | PVC windshield*1 |
| Carbon tube*1 | |
| Steel pull rod with PVC tube*1 | |

KIT FEATURES

- **Scheme-based on Schneider Grunau Baby.**
- **Extremely lightweight, state-of-the-art all-wood construction.**
- **Ultra-light take-off weight ensures high gliding performance.**
- **Full-scale simulation metallic structure.**
- **Extensive clear drawings and full-page color instructions with hundreds of pictures.**
- **Only adhesives and coverings are required to complete the airframe.**
- **Ultra-light take-off weight ensures high gliding performance.**

GENERAL INFORMATION

BE SURE TO READ THE SAFETY INSTRUCTIONS CAREFULLY BEFORE OPERATING YOUR MODEL.

- Always follow the procedures and settings recommended in the instructions.
- If you are using remote-controlled model aircraft, helicopters, cars or ships for the first time, we recommend that you ask an experienced model pilot for help.
- Remote-controlled models are not toys in the usual sense and may only be used and operated by young people under 14 years of age under the supervision of adults.
- Their construction and operation requires technical understanding, careful craftsmanship and safety-conscious behavior.
- Mistakes or negligence during construction, flying or driving can result in considerable damage to property or personal injury.
- Since the manufacturer and seller have no influence on the proper construction/assembly and operation of the models, these risks are expressly pointed out and any liability is excluded.
- Propellers on aircraft and all moving parts in general pose a constant risk of injury. Avoid touching such parts at all costs.
- Note that motors and controllers can reach high temperatures during operation. Avoid touching such parts at all costs.
- Never stay in the danger area of rotating parts with electric motors with connected drive battery.
- Overcharging or incorrect charging can cause the batteries to explode. Make sure the polarity is correct.
- Protect your equipment and Models from dust, dirt and moisture. Do not expose the equipment to excessive heat, cold or vibration.
- Always check your equipment for damage and replace defects with original spare parts.
- Do not use equipment that has been damaged or got wet due to a fall, even if it is dry again!
- Do not make any changes to the remote control which is not described in these instructions.
- Before the first flight, check the wing symmetry, tail unit and fuselage. All parts of the model should have the same spacing from the left and right wing or tail plane to the centre of the fuselage or the same angle.

ATTENTION, DANGER OF INJURY!

- Always keep a safe distance from your model aircraft.
- Never fly over spectators, other pilots or yourself.
- Always perform flight figures in a direction away from the pilot or spectators.
- Never endanger people or animals.
- Never fly near power lines or residential areas.
- Do not operate your model near locks or public shipping.
- Do not operate your model on public roads, motorways, paths and squares, etc., but only in approved locations.
- Do not operate the model in thunderstorms.
- Before each flight, check your remote control system for sufficient function and range.
- After flying, remove all batteries from the model.

Do not "aim" the transmitter antenna at the model during operation. In this direction, the transmitter has the lowest radiation. The best position of the antenna is to the side of the model.

Use of devices with image and/or sound recording function:

BUILDING INSTRUCTION

1 FUSELAGE FRAME ASSEMBLY

1-4 Glue the bottom plate, fix bulkheads and the servo mount, then paste the PVC tubes.

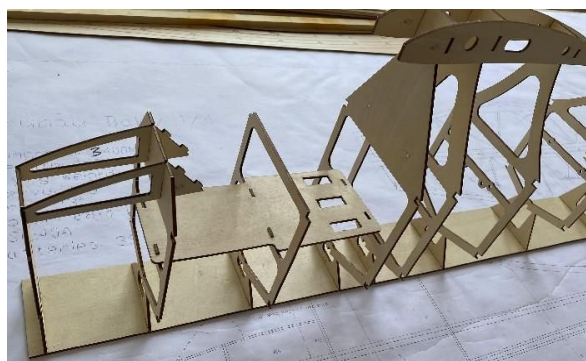

5-7 Wing platform cover plate of fuselage, cut out the line hole of aileron steering gear below, glue 8mm balsa sheet on the leading edge of the wing and sand it into shape, glue 6X6mm balsa to the bulkhead, use 6X6mm pine wood strips at the bottom front(for landing skid), and the rest are balsa wood strips.

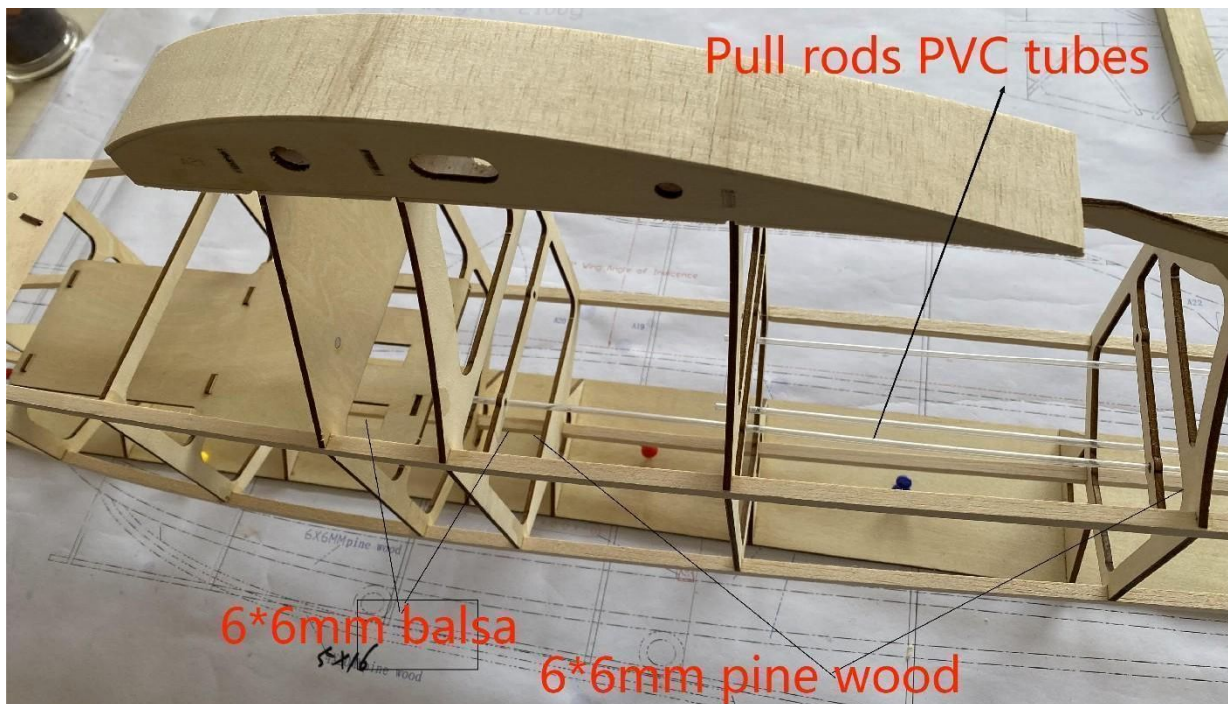

8. Splice the side cover (2mm balsa sheets) of the fuselage and sand the bevel surface to increase the bonding area.

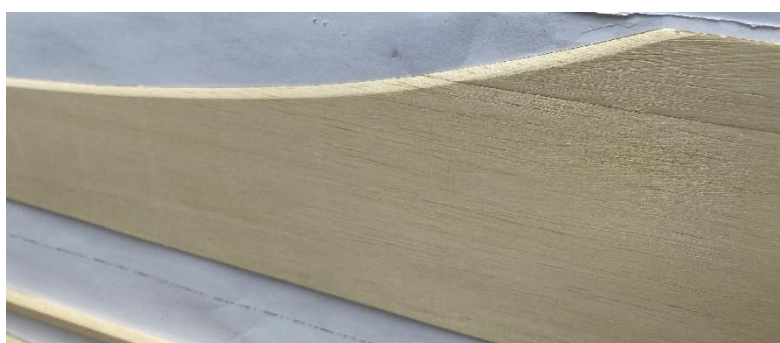

9-11 Glue the cover to the fuselage.



12 Sand the side cover and make sure it is perpendicular to the bulkheads.



13 Attach magnets to A16 balsa for fixing the cabin cover.



14-16 Glue 2mm balsa sheets.



17 Reinforce the enclosure with pine stick. (It will have metal connectors at both ends to attach the wing struts)
Note: The motor must be installed before pasting the mask; otherwise it is difficult to fix the motor with screws.



18-19 Glue the fuselage cover (2mm balsa). The length of the cover must be spliced.

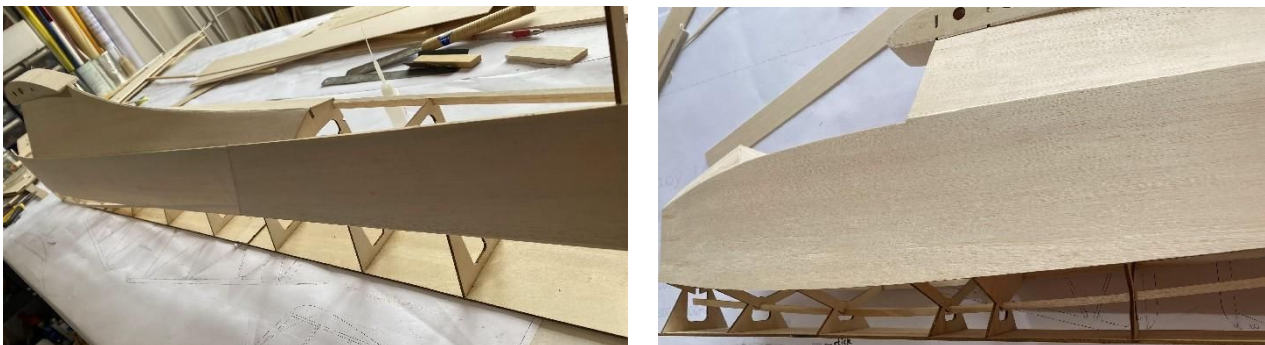

20-21 Bend the metal connectors and secure it to the fuselage (PIC17 pine sticks).



22-24 Glue the fuselage bottom cover.



25 The tail is reinforced with additional 6X6mm balsa sticks inside.



26-29 Tailplane was filled and glued with 8mm balsa sheets.

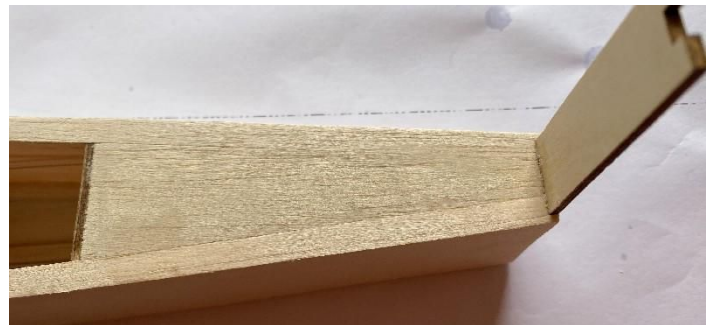

30-32 Build the vertical tail and cover according to the drawing (A23-24).

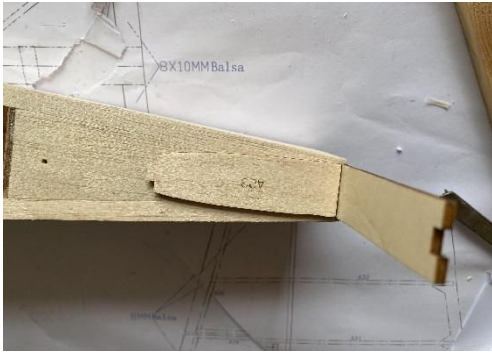

33-34 Drill holes in the horizontal tail fins and install T-nuts.



35-36 Mark the corresponding position of the PVC tube and cut out the pull rod hole.



37-38 Mark the fuselage with finished horizontal tail and elevators and cut out obstructions.

NOTE: steel pull rod with PVC tube controls the elevator, Dyneema rope controls rudder.)

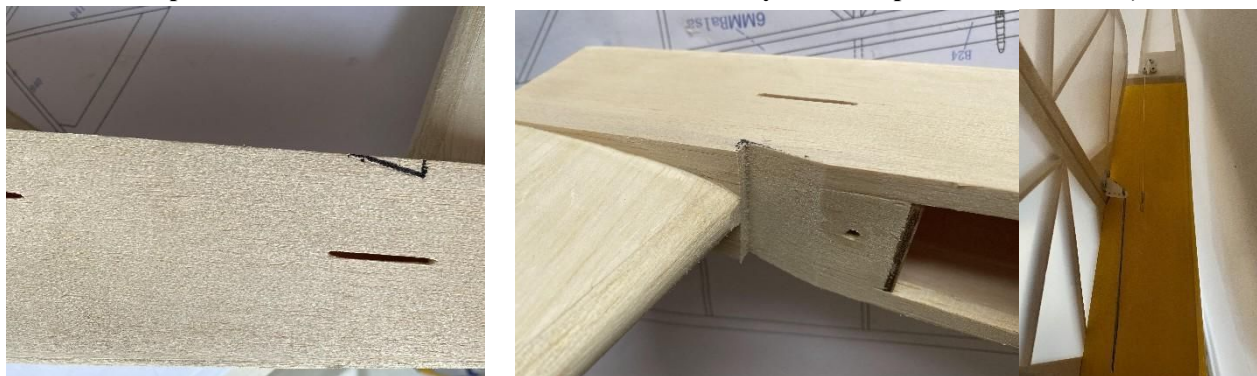

39-42 Use 8mm balsa sheets for the head section and 2pcs 8mm balsa sheets for bonding at the top.

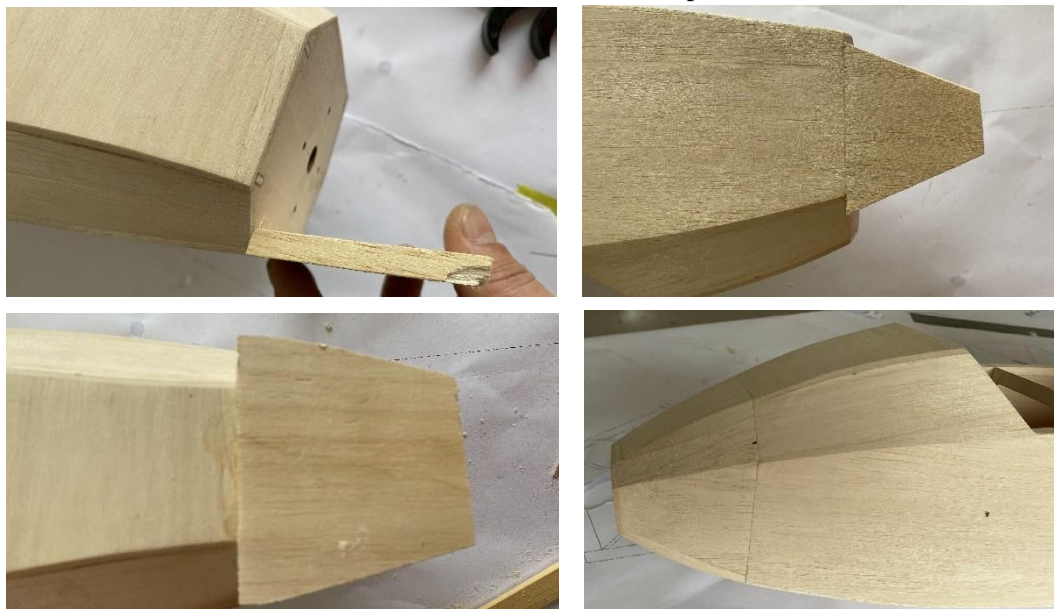

43-44 Steam 5X16mm pine sticks are heated for easy bending and forming.



45 The damping rubber is perforated to facilitate the installation of self-tapping screws.



46-47 The front of the landing skid is secured with tapping screws; the damping rubbers and landing skid are secured with wires.



48-51 Build the cabin frame and paste the mask. Magnets are required for parts 17 and 19.

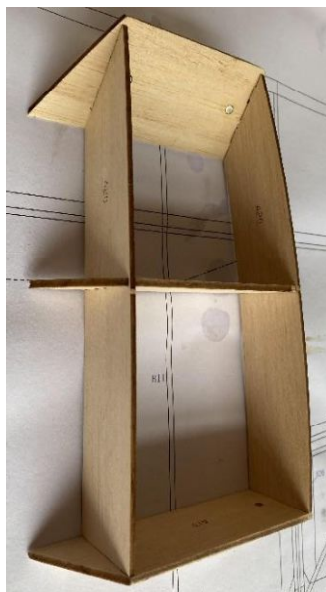

52 Install PVC windshields.

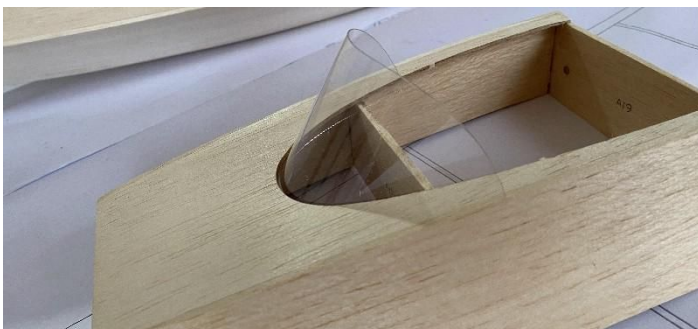

2 WINGS ASSEMBLY

53 Butt and glue the girder of the wings.



54-57 Install the wing ribs according to the drawing and paste 6X6mm balsa strips. The length of balsa strips shall be spliced.



58 Preset the PVC tube (for carbon tube) in the wing.



59-60 Two pcs of 3mm plywood are used for reinforcement at the position where the wing strut is attached.

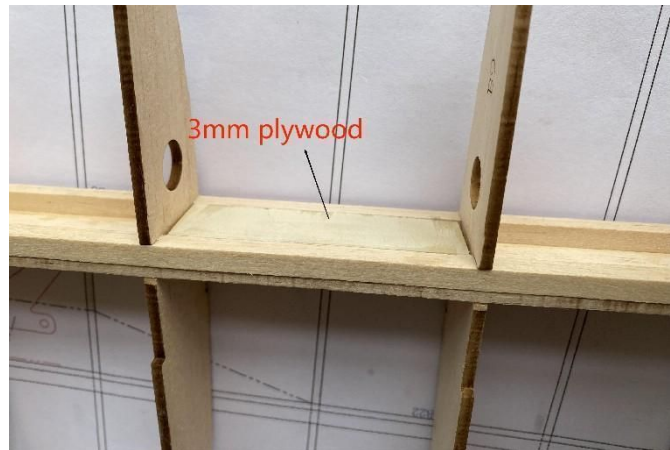
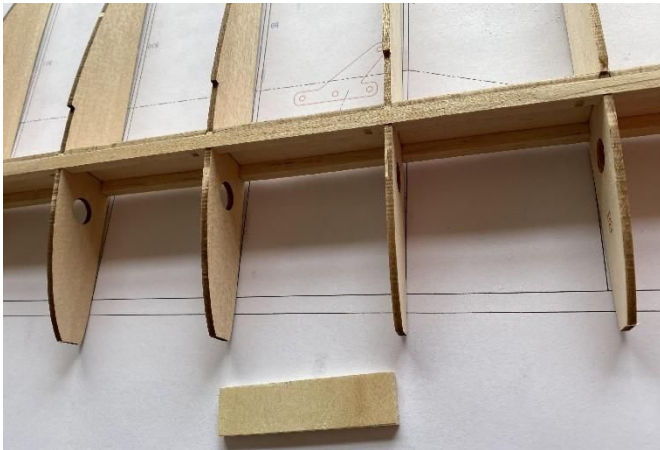

61 Splice the wing cover (2mm balsa).



62-64 Glue the cover for the leading edge of the wing.



65-66 Glue 8mm balsa sheets on the leading edge of the wing and sand them into shape.



67-70 Glue the cover to the root and middle of the wing.



71 8mm balsa wood for the wing tips.



72-74 Assemble ailerons according to the drawings.

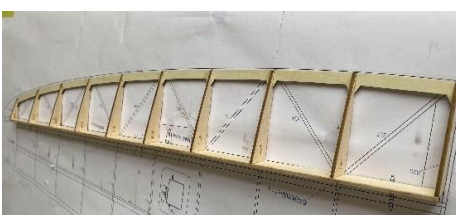

75 Strengthen aileron roots with 3mm balsa sheet.

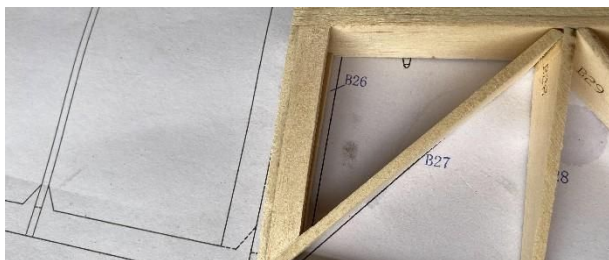

76 Glue 6mm balsa sheets on the ailerons and sanded into triangles.



77-80 Make aileron servo mounts according to the drawings.

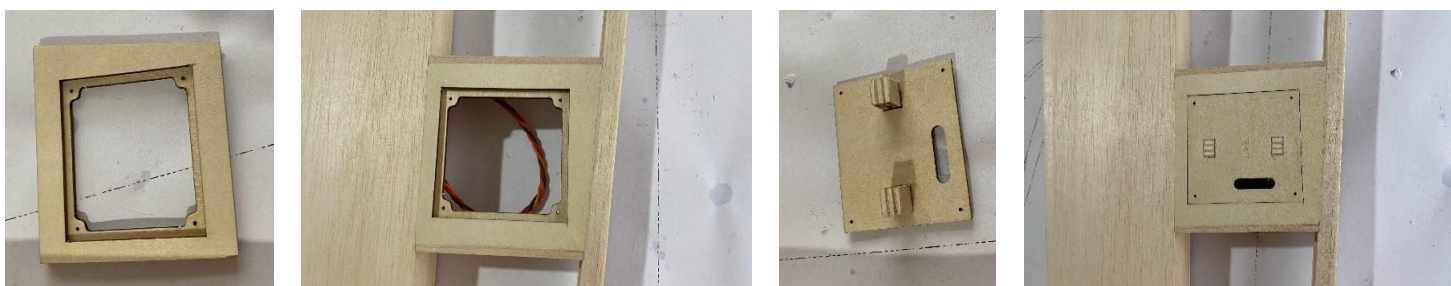

81-82 Cut a hole in the metal connector, pass it through the connector, and secure it using tapping screws.



83-84 Drill 2.5mm holes in the 8X14mm pine strips and trim the strips to streamline.

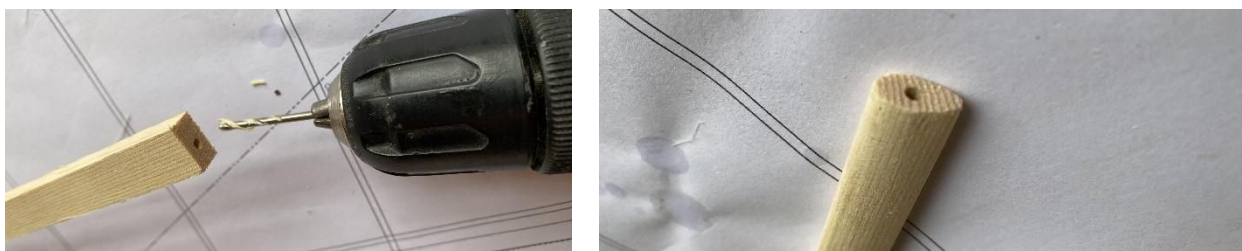

85-86 Screw the 3X40mm screws into the pine bar, and cut off the tail of the screws, screw into the copper clevis at both ends, and the length of both sides can be adjusted.

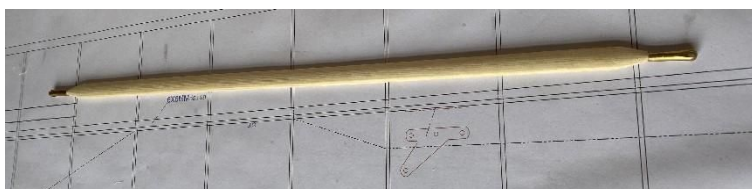

3 TAIL ASSEMBLY DETAILS

87-88 Assemble the rudder according to the drawing, and glue cover at the front part.

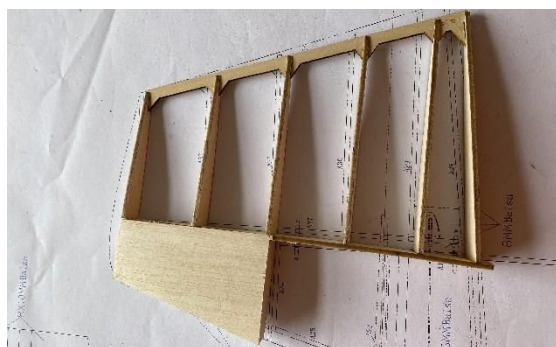

89-90 Glue 6mm balsa sheets on the front and sand them into a triangle shape. Glue balsa reinforcement blocks on the rudder corners.



91 Glue 8mm balsa on the upper and lower part of the rudder and sand them into shape.



92-94 The horizontal tail is built according to the drawing, and 8mm balsa sheets are used for the reinforcement part.

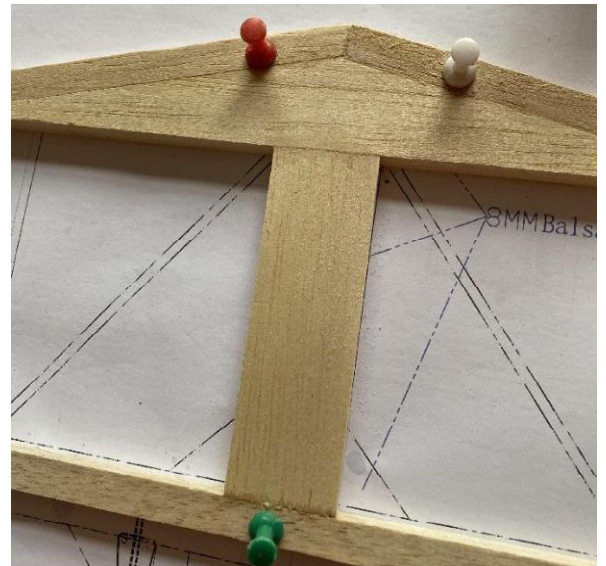
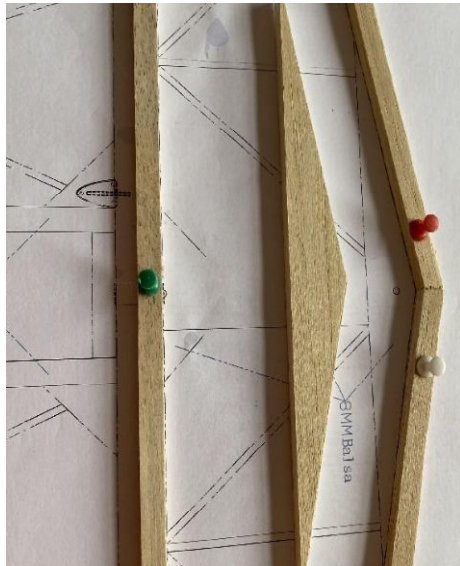

95-97 Glue 3mm balsa sheets.

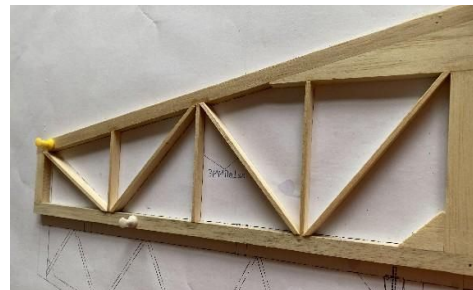
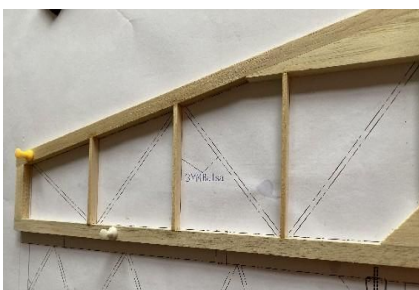

98 Remove the excess in front of the horizontal stabilizer.

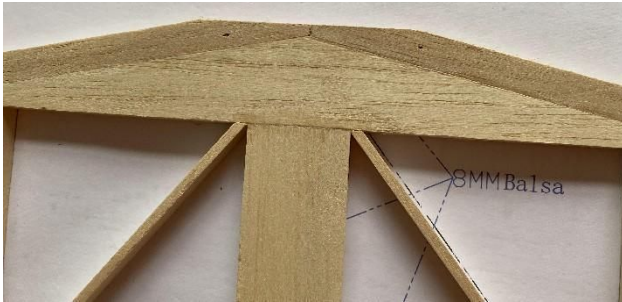

99-100 Build the elevator according to the drawing.

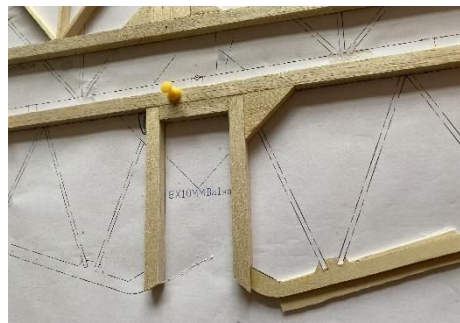
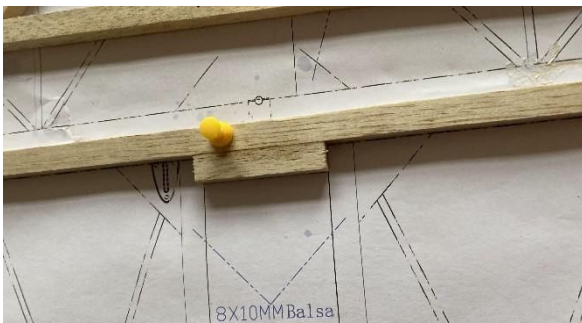

101-103 Glue 3mm balsa sheets and sand them into shape. Sand the leading edge into a triangle.

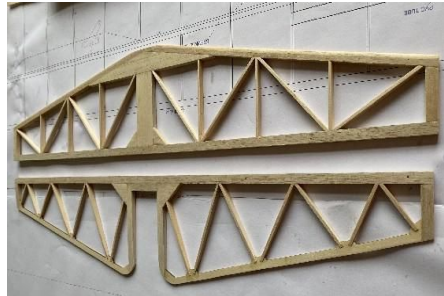
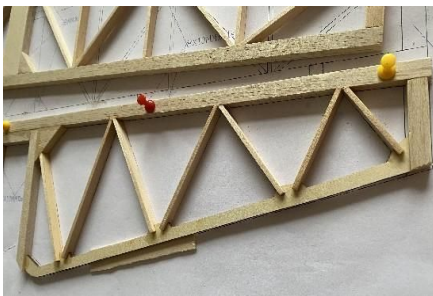

4 STRUCTURAL VIEWS

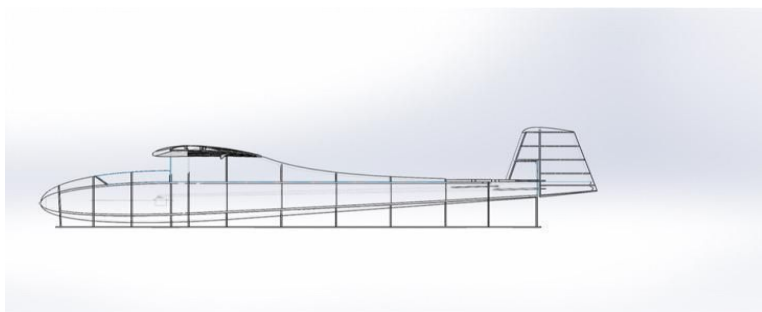
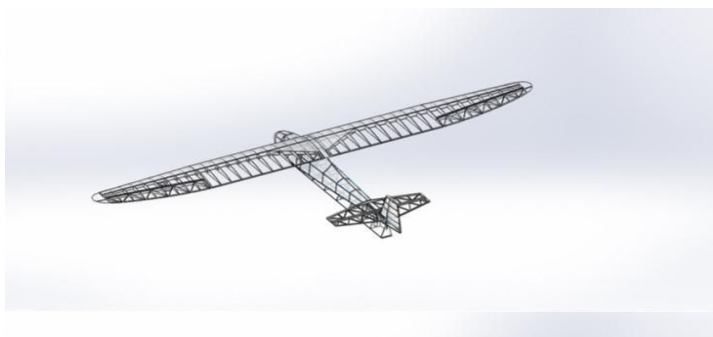
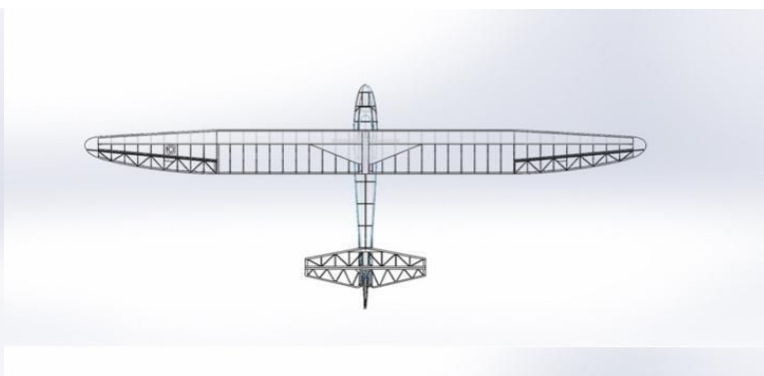
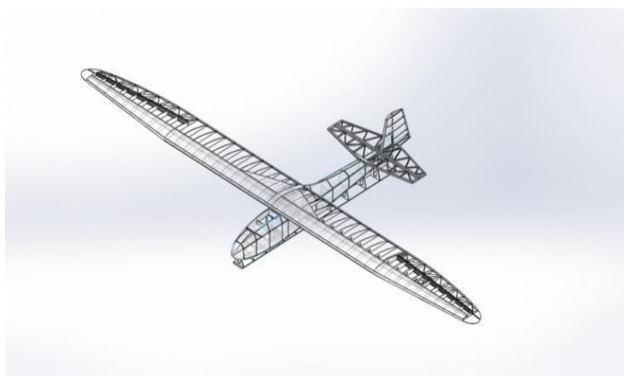

4 ASSEMBLY

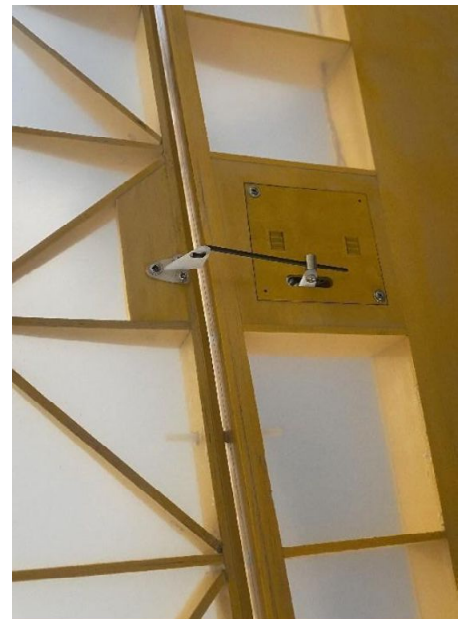

4 FINISHED

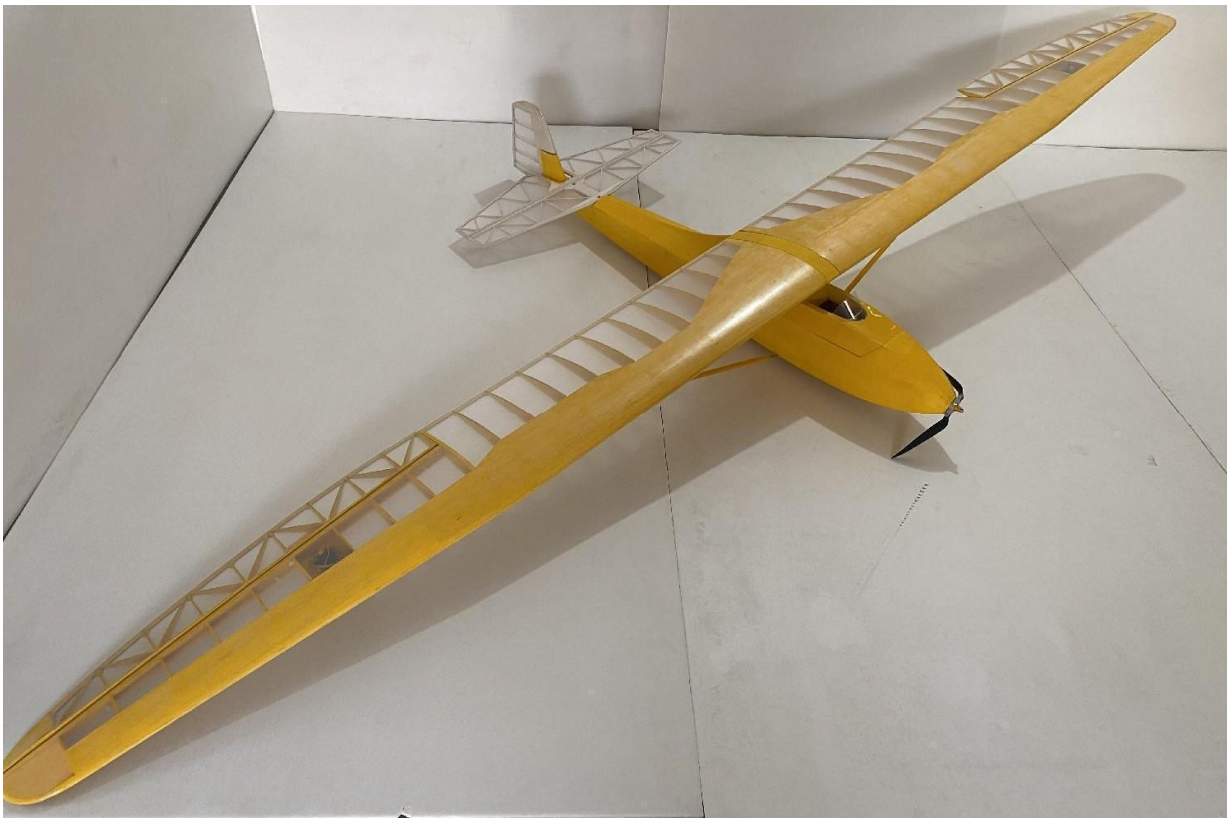
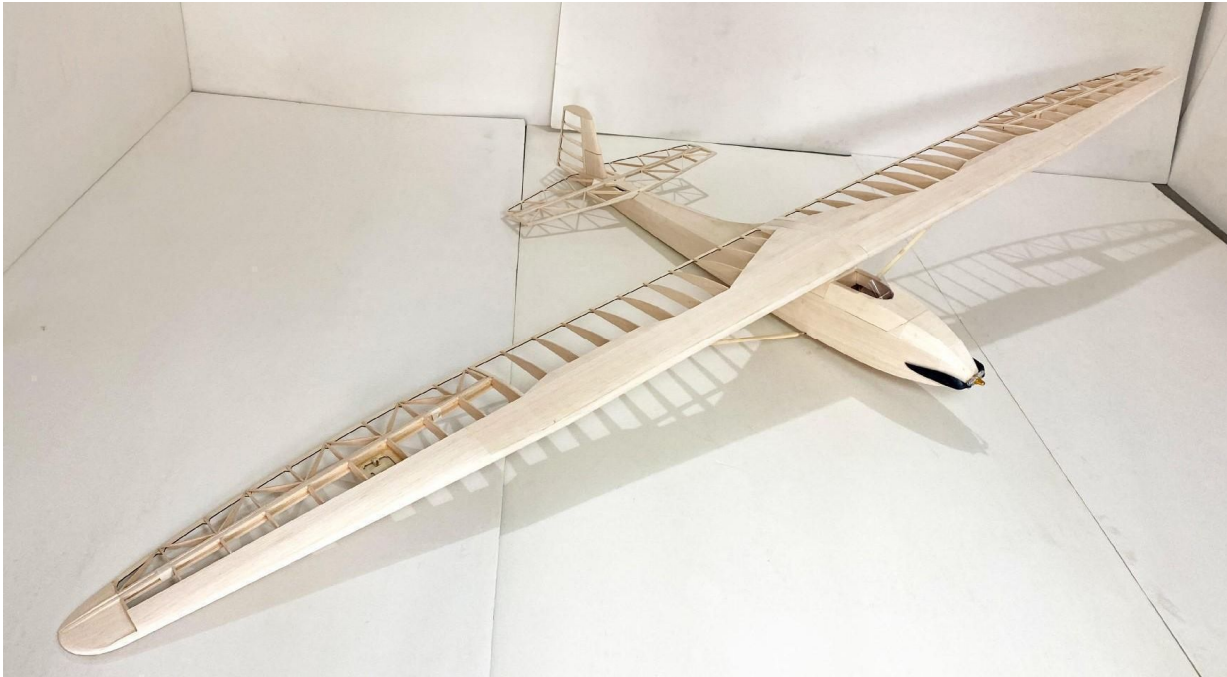



Sales: sales@valueplanes.com

Tech: tech@valueplanes.com